



SAMXON BRAND ALUMINUM ELECTROLYTIC CAPACITORS

PRODUCT SPECIFICATION

規格書

CUSTOMER : (客戶):	DATE : (日期): 2017-08-04
----------------------------	-----------------------------------

CATEGORY (品名)	: ALUMINUM ELECTROLYTIC CAPACITORS
DESCRIPTION (型号)	: RT 250V220 μ F(ϕ 18x35)
VERSION (版本)	: 01
Customer P/N	:
SUPPLIER	:

SUPPLIER	
PREPARED (拟定)	CHECKED (审核)
李婷	刘渭清

CUSTOMER	
APPROVAL (批准)	SIGNATURE (签名)

MAN YUE ELECTRONICS COMPANY LIMITED	<i>ELECTROLYTIC CAPACITOR SPECIFICATION RT SERIES</i>	SAMXON

SPECIFICATION					ALTERNATION HISTORY RECORDS		
RT SERIES							
Rev.	Date	Mark	Page	Contents	Purpose	Drafter	Approver

Issued-date: 2017-08-04	Name	Specification Sheet – RT					
Version	01				Page	1	
STANDARD MANUAL							

MAN YUE ELECTRONICS COMPANY LIMITED	<i>ELECTROLYTIC CAPACITOR SPECIFICATION RT SERIES</i>	SAMXON	

PART NUMBERING REFERENCE		
Specification	Customer P/N	SAMXON P/N
RT 250V220 μ F (Φ 18x35)		ERT227M2EL35RRS0P

Issued-date: 2017-08-04	Name	Specification Sheet – RT	
Version	01	Page	2
STANDARD MANUAL			

MAN YUE ELECTRONICS COMPANY LIMITED	ELECTROLYTIC CAPACITOR SPECIFICATION RT SERIES	SAMXON	

SPECIFICATION FOR CAPACITOR

Customer: 飞宏

Your's Part Number		SLEEVE	BLACK (PET)
SAMXON P/N	ERT227M2EL35RRS0P	CASE	AL
SERIES	RT	TERMANAL	CP WIRE (LEAD-Pb FREE)
RATING	250V220 μ F	TYPE	BULK
SIZE	18X35	REMARK	

1. Dimension and size

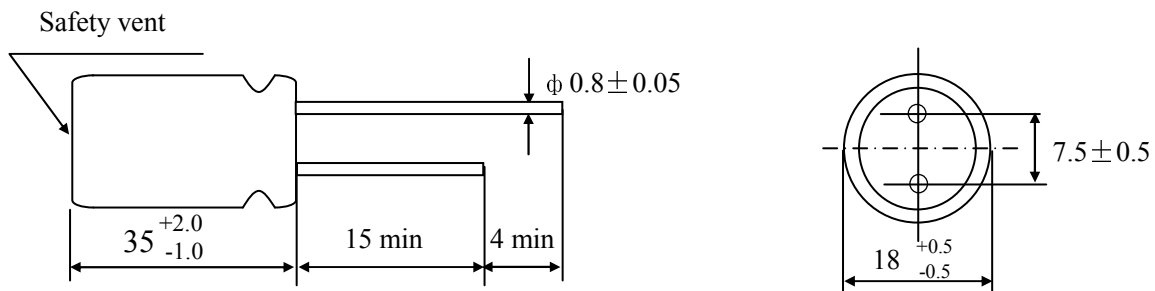

2. Performance Characteristic

SAMXON Series	Rated Voltage (V.DC)	Nominal Capacitance	Size (mm)	DF (%) Max 20°C 120Hz	Leakage Current (μ A) 2minutes	Ripple Current (mA) 105°C 120Hz	Load Life (Hours)
RT	250	220	18x35	15	1125	1110	5000

Moisture content of electrolyte ≤ 5%

3. Marking Unless otherwise specified Capacitor shall be clearly marked on it body.

- (1) Brand SAMXON
- (2) Nominal capacitance 220 μ F
- (3) Rated voltage 250V
- (4) Polarity
- (5) Series (Tolerance) RT (M)
- (6) Date Code G1A
- (7) Temperature 105°C H
- (8) Sleeve color Black Ink Color White

4. Multiplier for ripple current

Frequency multipliers:

Coefficient	Freq. (Hz)			
	120	1k	10k	100k
6.8~180	0.40	0.75	0.90	1.00

Temperature coefficient:

Temperature (°C)	~55	65	75	85	105
Factor	1.73	1.73	1.73	1.73	1.00

Issued-date: 2017-08-04	Name	Specification Sheet – RT		
Version	01	Page	3	
STANDARD MANUAL				

MAN YUE ELECTRONICS COMPANY LIMITED	<i>ELECTROLYTIC CAPACITOR SPECIFICATION RT SERIES</i>	SAMXON	

C O N T E N T S		Sheet
1. Application		5
2. Part Number System		5
3. Construction		6
4. Characteristics		7~14
4.1 Rated voltage & Surge voltage		
4.2 Capacitance (Tolerance)		
4.3 Leakage current		
4.4 $\tan \delta$		
4.5 Terminal strength		
4.6 Temperature characteristics		
4.7 Load life test		
4.8 Shelf life test		
4.9 Surge test		
4.10 Vibration		
4.11 Solderability test		
4.12 Resistance to solder heat		
4.13 Change of temperature		
4.14 Damp heat test		
4.15 Vent test		
4.16 Maximum permissible (ripple current, temperature coefficient)		
5. Product Marking		15
6. Product Dimensions & Maximum Permissible Ripple Current		16
7. List of “Environment-related Substances to be Controlled (‘Controlled Substances’)”		17 18
Attachment: Application Guidelines		19~23

Issued-date: 2017-08-04	Name	Specification Sheet – RT		
Version	01	Page	4	
STANDARD MANUAL				

1. Application

This specification applies to polar Aluminum electrolytic capacitor (foil type) used in electronic equipment.

Designed capacitor's quality meets IEC60384.

2. Part Number System

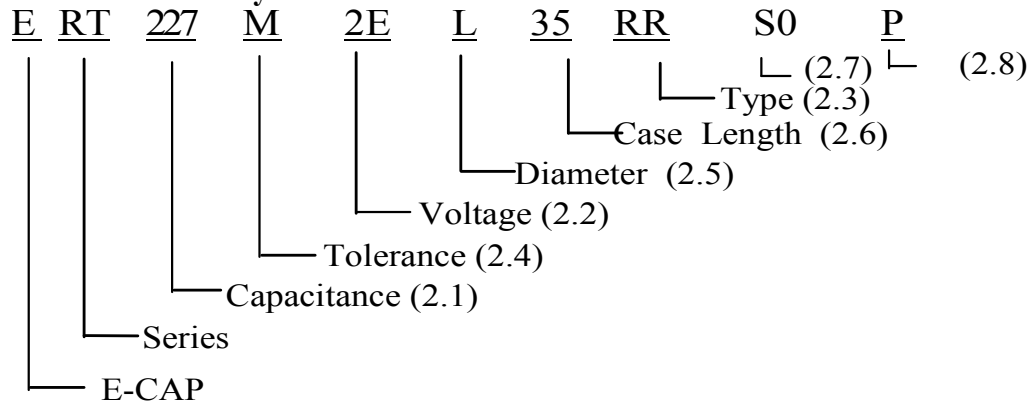

2.1 Capacitance code

Code	227
Capacitance (μ F)	220

2.2 Rated voltage code

Code	2E
Voltage (W.V.)	250

2.3 Type

Code	RR
Reference	Bulk.

2.4 Capacitance tolerance

“M” stands for -20% ~ +20%

2.5 Diameter

Code	L
Diameter	18

2.6 Case length

35=35mm

2.7 “S0” indicates production line.

2.8 “P” PET sleeve.

3. Construction

Single ended type to be produced to fix the terminals to anode and cathode foil, and wind together with paper, and then wound element to be impregnated with electrolyte will be enclosed in an aluminum case. Finally sealed up tightly with end seal rubber, then finished by putting on the vinyl sleeve.

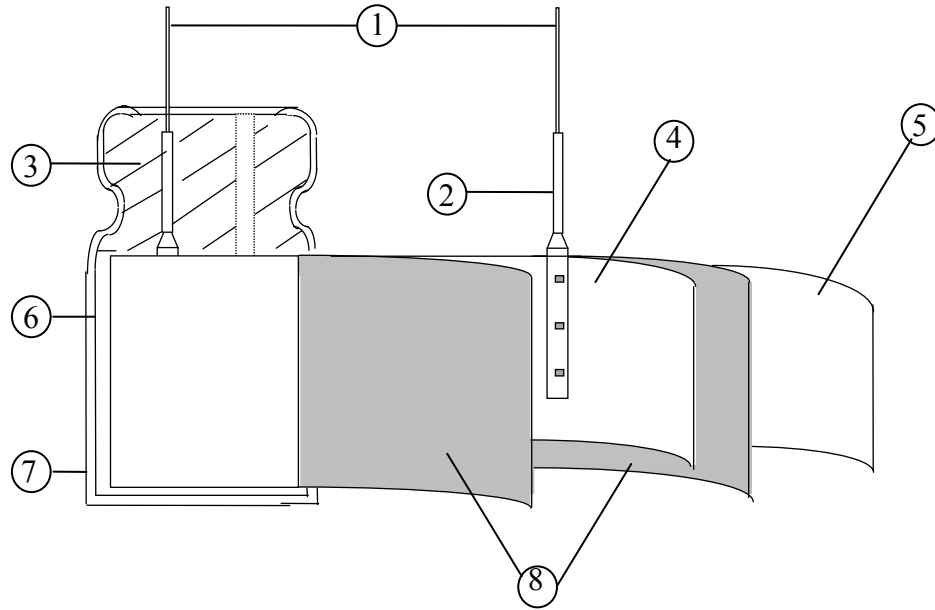

No	Component	Material
1	Lead line	Tinned CP wire (Pb Free) RoHS
2	Terminal	Aluminum wire
3	Sealing Material	Rubber
4	Al-Foil (+)	Formed aluminum foil
5	Al-Foil (-)	Etched aluminum foil or formed aluminum foil
6	Case	Aluminum case
7	Sleeve	PET Halogen free Black
8	Separator	Electrolyte paper
9	Ink Color	White

MAN YUE ELECTRONICS COMPANY LIMITED	<i>ELECTROLYTIC CAPACITOR SPECIFICATION RT SERIES</i>	SAMXON	

4. Characteristics

Standard atmospheric conditions

Unless otherwise specified, the standard range of atmospheric conditions for making measurements and tests is as follows:

Ambient temperature	: 15°C to 35°C
Relative humidity	: 45% to 85%
Air Pressure	: 86kPa to 106kPa

If there is any doubt about the results, measurement shall be made within the following conditions:

Ambient temperature	: 20°C ± 2°C
Relative humidity	: 60% to 70%
Air Pressure	: 86kPa to 106kPa

Operating temperature range

The ambient temperature range at which the capacitor can be operated continuously at rated voltage is -40°C to 105°C.

As to the detailed information, please refer to table 1

Issued-date: 2017-08-04	Name	Specification Sheet – RT		
Version	01		Page	7
STANDARD MANUAL				

Table 1

ITEM		PERFORMANCE				
4.1	Rated voltage (WV) Surge voltage (SV)	<table border="1"> <tr> <td>WV (V.DC)</td> <td>250</td> </tr> <tr> <td>SV (V.DC)</td> <td>300</td> </tr> </table>	WV (V.DC)	250	SV (V.DC)	300
WV (V.DC)	250					
SV (V.DC)	300					
4.2	Nominal capacitance (Tolerance)	<p><Condition> Measuring Frequency : 120Hz±12Hz Measuring Voltage : Not more than 0.5Vrms Measuring Temperature : 20±2°C</p> <p><Criteria> Shall be within the specified capacitance tolerance.</p>				
4.3	Leakage current	<p><Condition> Connecting the capacitor with a protective resistor (1kΩ ± 10Ω) in series for 2 minutes, and then, measure Leakage Current.</p> <p><Criteria> $I \leq 0.02CV + 25 (\mu A)$</p> <p>I: Leakage current (μA) C: Capacitance (μF) V: Rated DC Working Voltage (V)</p>				
4.4	tan δ	<p><Condition> See 4.2, Norm Capacitance, for measuring frequency, voltage and temperature.</p> <p><Criteria></p> <table border="1"> <tr> <td>Working voltage (v)</td> <td>250</td> </tr> <tr> <td>tan δ (max.)</td> <td>0.15</td> </tr> </table>	Working voltage (v)	250	tan δ (max.)	0.15
Working voltage (v)	250					
tan δ (max.)	0.15					

4.5	Terminal strength	<p><Condition> Tensile Strength of Terminals Fixed the capacitor, applied force to the terminal in lead out direction for 10 ± 1 seconds. Bending Strength of Terminals Fixed the capacitor, applied force to bent the terminal (1~4 mm from the rubber) for 90° within 2~3 seconds, and then bent it for 90° to its original position within 2~3 seconds.</p> <table border="1"> <thead> <tr> <th>Diameter of lead wire</th> <th>Tensile force N (kgf)</th> <th>Bending force N (kgf)</th> </tr> </thead> <tbody> <tr> <td>Over 0.5mm to 0.8mm</td> <td>10(1.0)</td> <td>5(0.51)</td> </tr> </tbody> </table> <p><Criteria> No noticeable changes shall be found, no breakage or looseness at the terminal.</p>	Diameter of lead wire	Tensile force N (kgf)	Bending force N (kgf)	Over 0.5mm to 0.8mm	10(1.0)	5(0.51)												
Diameter of lead wire	Tensile force N (kgf)	Bending force N (kgf)																		
Over 0.5mm to 0.8mm	10(1.0)	5(0.51)																		
4.6	Temperature characteristics	<p><Condition></p> <table border="1"> <thead> <tr> <th>STEP</th> <th>Testing Temperature($^\circ\text{C}$)</th> <th>Time</th> </tr> </thead> <tbody> <tr> <td>1</td> <td>20 ± 2</td> <td>Time to reach thermal equilibrium</td> </tr> <tr> <td>2</td> <td>-25 ± 3</td> <td>Time to reach thermal equilibrium</td> </tr> <tr> <td>3</td> <td>20 ± 2</td> <td>Time to reach thermal equilibrium</td> </tr> <tr> <td>4</td> <td>105 ± 2</td> <td>Time to reach thermal equilibrium</td> </tr> <tr> <td>5</td> <td>20 ± 2</td> <td>Time to reach thermal equilibrium</td> </tr> </tbody> </table> <p><Criteria> a. At $+105^\circ\text{C}$, capacitance measured shall be within $\pm 20\%$ of its original value at $+20^\circ\text{C}$. tan δ shall be within the limit of Item 4.4 The leakage current measured shall not more than 8 times of its specified value. b. In step 5, tan δ shall be within the limit of Item 4.4 The leakage current shall not more than the specified value.</p>	STEP	Testing Temperature($^\circ\text{C}$)	Time	1	20 ± 2	Time to reach thermal equilibrium	2	-25 ± 3	Time to reach thermal equilibrium	3	20 ± 2	Time to reach thermal equilibrium	4	105 ± 2	Time to reach thermal equilibrium	5	20 ± 2	Time to reach thermal equilibrium
STEP	Testing Temperature($^\circ\text{C}$)	Time																		
1	20 ± 2	Time to reach thermal equilibrium																		
2	-25 ± 3	Time to reach thermal equilibrium																		
3	20 ± 2	Time to reach thermal equilibrium																		
4	105 ± 2	Time to reach thermal equilibrium																		
5	20 ± 2	Time to reach thermal equilibrium																		

MAN YUE ELECTRONICS COMPANY LIMITED	ELECTROLYTIC CAPACITOR SPECIFICATION RT SERIES	SAMXON	

4.6		<p>c. At-25 °C , impedance (Z) ratio shall not exceed the value of the following table.</p> <table border="1"> <tr> <td>Working Voltage (V)</td> <td>250</td> </tr> <tr> <td>Z-25 °C/Z+20 °C</td> <td>3</td> </tr> </table> <p>Capacitance, $\tan \delta$, and impedance shall be measured at 120Hz.</p>	Working Voltage (V)	250	Z-25 °C/Z+20 °C	3				
Working Voltage (V)	250									
Z-25 °C/Z+20 °C	3									
4.7	Load life test	<p><Condition> According to IEC60384-4No.4.13 methods, The capacitor is stored at a temperature of 105 ± 2 °C with DC bias voltage plus the rated ripple current for 5000+48/0hours. (Sum of the DC voltage and super-imposed peak AC voltage for maximum permissible ripple current should be equal to rated DC working voltage) Then the product should be tested after 16 hours recovering time at atmospheric conditions. The result should meet the following table:</p> <p><Criteria> The characteristic shall meet the following requirements.</p> <table border="1"> <tr> <td>Leakage current</td> <td>Value in 4.3 shall be satisfied</td> </tr> <tr> <td>Capacitance Change</td> <td>Within $\pm 20\%$ of initial value</td> </tr> <tr> <td>$\tan \delta$</td> <td>Not more than 200%of the specified value.</td> </tr> <tr> <td>Appearance</td> <td>There shall be no leakage of electrolyte.</td> </tr> </table>	Leakage current	Value in 4.3 shall be satisfied	Capacitance Change	Within $\pm 20\%$ of initial value	$\tan \delta$	Not more than 200%of the specified value.	Appearance	There shall be no leakage of electrolyte.
Leakage current	Value in 4.3 shall be satisfied									
Capacitance Change	Within $\pm 20\%$ of initial value									
$\tan \delta$	Not more than 200%of the specified value.									
Appearance	There shall be no leakage of electrolyte.									
4.8	Shelf life test	<p><Condition> The capacitors are then stored with no voltage applied at a temperature of 105 ± 2 °C for 1000+48/0 hours. Following this period the capacitors shall be removed from the test chamber and be allowed to stabilized at room temperature for 4~8 hours. Next they shall be connected to a series limiting resistor($1k \pm 100 \Omega$) with D.C. rated voltage applied for 30min. After which the capacitors shall be discharged, and then, tested the characteristics.</p> <p><Criteria> The characteristic shall meet the following requirements.</p> <table border="1"> <tr> <td>Leakage current</td> <td>Value in 4.3 shall be satisfied</td> </tr> <tr> <td>Capacitance Change</td> <td>Within $\pm 20\%$ of initial value</td> </tr> <tr> <td>$\tan \delta$</td> <td>Not more than 200%of the specified value.</td> </tr> <tr> <td>Appearance</td> <td>There shall be no leakage of electrolyte.</td> </tr> </table> <p>Remark: If the capacitors are stored more than 1 year, the leakage current may increase. Please apply voltage through about 1 kΩ resistor, if necessary.</p>	Leakage current	Value in 4.3 shall be satisfied	Capacitance Change	Within $\pm 20\%$ of initial value	$\tan \delta$	Not more than 200%of the specified value.	Appearance	There shall be no leakage of electrolyte.
Leakage current	Value in 4.3 shall be satisfied									
Capacitance Change	Within $\pm 20\%$ of initial value									
$\tan \delta$	Not more than 200%of the specified value.									
Appearance	There shall be no leakage of electrolyte.									

Issued-date: 2017-08-04	Name	Specification Sheet – RT		
Version	01	Page	10	
STANDARD MANUAL				

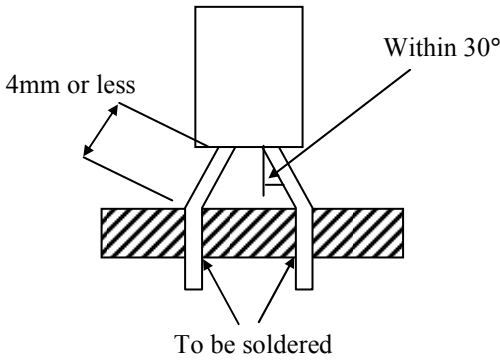
4.9	Surge test	<p><Condition> Applied a surge voltage to the capacitor connected with a $(100 \pm 50)/C_R$ ($k\Omega$) resistor. The capacitor shall be submitted to 1000 cycles, each consisting of charge of $30 \pm 5s$, followed discharge of 5 min 30s. The test temperature shall be $15 \sim 35^\circ C$. C_R :Nominal Capacitance (μF)</p> <p><Criteria></p> <table border="1" style="width: 100%; border-collapse: collapse;"> <tr> <td style="width: 50%;">Leakage current</td> <td>Not more than the specified value.</td> </tr> <tr> <td>Capacitance Change</td> <td>Within $\pm 15\%$ of initial value .</td> </tr> <tr> <td>$\tan \delta$</td> <td>Not more than the specified value.</td> </tr> <tr> <td>Appearance</td> <td>There shall be no leakage of electrolyte.</td> </tr> </table> <p>Attention: This test simulates over voltage at abnormal situation only. It is not applicable to such over voltage as often applied.</p>	Leakage current	Not more than the specified value.	Capacitance Change	Within $\pm 15\%$ of initial value .	$\tan \delta$	Not more than the specified value.	Appearance	There shall be no leakage of electrolyte.
Leakage current	Not more than the specified value.									
Capacitance Change	Within $\pm 15\%$ of initial value .									
$\tan \delta$	Not more than the specified value.									
Appearance	There shall be no leakage of electrolyte.									
4.10	Vibration test	<p><Condition> The following conditions shall be applied for 2 hours in each 3 mutually perpendicular directions. Vibration frequency range : 10Hz ~ 55Hz Peak to peak amplitude : 1.5mm Sweep rate : 10Hz ~ 55Hz ~ 10Hz in about 1 minute Mounting method: The capacitor with diameter greater than 12.5mm or longer than 25mm must be fixed in place with a bracket.</p> <div style="text-align: center;">  <p style="text-align: center;">4mm or less</p> <p style="text-align: center;">Within 30°</p> <p style="text-align: center;">To be soldered</p> </div>								

		<p><Criteria> After the test, the following items shall be tested:</p> <table border="1"> <tr> <td>Inner construction</td> <td>No intermittent contacts, open or short circuiting. No damage of tab terminals or electrodes.</td> </tr> <tr> <td>Appearance</td> <td>No mechanical damage in terminal. No leakage of electrolyte or swelling of the case. The markings shall be legible.</td> </tr> </table>	Inner construction	No intermittent contacts, open or short circuiting. No damage of tab terminals or electrodes.	Appearance	No mechanical damage in terminal. No leakage of electrolyte or swelling of the case. The markings shall be legible.				
Inner construction	No intermittent contacts, open or short circuiting. No damage of tab terminals or electrodes.									
Appearance	No mechanical damage in terminal. No leakage of electrolyte or swelling of the case. The markings shall be legible.									
4.11	Solderability test	<p><Condition> The capacitor shall be tested under the following conditions: Soldering temperature : 245±3°C Dipping depth : 2mm Dipping speed : 25±2.5mm/s Dipping time : 3±0.5s</p> <p><Criteria></p> <table border="1"> <tr> <td>Coating quality</td> <td>A minimum of 95% of the surface being immersed</td> </tr> </table>	Coating quality	A minimum of 95% of the surface being immersed						
Coating quality	A minimum of 95% of the surface being immersed									
4.12	Resistance to solder heat test	<p><Condition> Terminals of the capacitor shall be immersed into solder bath at 260 ± 5 °C for 10 ± 1 seconds or 400 ± 10 °C for 3⁺¹₋₀ seconds to 1.5~2.0mm from the body of capacitor.</p> <p>Then the capacitor shall be left under the normal temperature and normal humidity for 1~2 hours before measurement.</p> <p><Criteria></p> <table border="1"> <tr> <td>Leakage current</td> <td>Not more than the specified value.</td> </tr> <tr> <td>Capacitance Change</td> <td>Within ±10% of initial value .</td> </tr> <tr> <td>tan δ</td> <td>Not more than the specified value.</td> </tr> <tr> <td>Appearance</td> <td>There shall be no leakage of electrolyte.</td> </tr> </table>	Leakage current	Not more than the specified value.	Capacitance Change	Within ±10% of initial value .	tan δ	Not more than the specified value.	Appearance	There shall be no leakage of electrolyte.
Leakage current	Not more than the specified value.									
Capacitance Change	Within ±10% of initial value .									
tan δ	Not more than the specified value.									
Appearance	There shall be no leakage of electrolyte.									

4.13	Change of temperature test	<p><Condition> Temperature Cycle: According to IEC60384-4 No.4.7 methods, capacitor shall be placed in an oven, the condition according as below:</p> <table border="1"> <thead> <tr> <th>Temperature</th> <th>Time</th> </tr> </thead> <tbody> <tr> <td>(1)+20℃</td> <td>≤3 Minutes</td> </tr> <tr> <td>(2)Rated low temperature(-40℃)</td> <td>30±2 Minutes</td> </tr> <tr> <td>(3)Rated high temperature (+105℃)</td> <td>30±2 Minutes</td> </tr> <tr> <td colspan="2">(1) to (3)=1 cycle, total 5 cycle</td> </tr> </tbody> </table> <p><Criteria> The characteristic shall meet the following requirement</p> <table border="1"> <tr> <td>Leakage current</td> <td>Not more than the specified value.</td> </tr> <tr> <td>tan δ</td> <td>Not more than the specified value.</td> </tr> <tr> <td>Appearance</td> <td>There shall be no leakage of electrolyte.</td> </tr> </table>	Temperature	Time	(1)+20℃	≤3 Minutes	(2)Rated low temperature(-40℃)	30±2 Minutes	(3)Rated high temperature (+105℃)	30±2 Minutes	(1) to (3)=1 cycle, total 5 cycle		Leakage current	Not more than the specified value.	tan δ	Not more than the specified value.	Appearance	There shall be no leakage of electrolyte.
Temperature	Time																	
(1)+20℃	≤3 Minutes																	
(2)Rated low temperature(-40℃)	30±2 Minutes																	
(3)Rated high temperature (+105℃)	30±2 Minutes																	
(1) to (3)=1 cycle, total 5 cycle																		
Leakage current	Not more than the specified value.																	
tan δ	Not more than the specified value.																	
Appearance	There shall be no leakage of electrolyte.																	
4.14	Damp heat test	<p><Condition> Humidity Test: According to IEC60384-4 No.4.12 methods, capacitor shall be exposed for 500±8 hours in an atmosphere of 90~95%R H .at 40±2℃, the characteristic change shall meet the following requirement.</p> <p><Criteria></p> <table border="1"> <tr> <td>Leakage current</td> <td>Not more than the specified value.</td> </tr> <tr> <td>Capacitance Change</td> <td>Within ±20% of initial value.</td> </tr> <tr> <td>tan δ</td> <td>Not more than 120% of the specified value.</td> </tr> <tr> <td>Appearance</td> <td>There shall be no leakage of electrolyte.</td> </tr> </table>	Leakage current	Not more than the specified value.	Capacitance Change	Within ±20% of initial value.	tan δ	Not more than 120% of the specified value.	Appearance	There shall be no leakage of electrolyte.								
Leakage current	Not more than the specified value.																	
Capacitance Change	Within ±20% of initial value.																	
tan δ	Not more than 120% of the specified value.																	
Appearance	There shall be no leakage of electrolyte.																	

4.15	Vent test	<p><Condition> The following test only apply to those products with vent products at diameter $\geq \varnothing 6.3$ with vent. D.C. test The capacitor is connected with its polarity reversed to a DC power source. Then a current selected from Table 2 is applied.</p> <p><Table 2></p> <table border="1" style="margin-left: auto; margin-right: auto;"> <tr> <th style="text-align: center;">Diameter (mm)</th> <th style="text-align: center;">DC Current (A)</th> </tr> <tr> <td style="text-align: center;">22.4 or less</td> <td style="text-align: center;">1</td> </tr> </table> <p><Criteria> The vent shall operate with no dangerous conditions such as flames or dispersion of pieces of the capacitor and/or case.</p>	Diameter (mm)	DC Current (A)	22.4 or less	1																							
Diameter (mm)	DC Current (A)																												
22.4 or less	1																												
4.16	Maximum permissible (ripple current, temperature coefficient)	<p><Condition> The maximum permissible ripple current is the maximum A.C current at 100KHz and can be applied at maximum operating temperature Table-3 The combined value of D.C voltage and the peak A.C voltage shall not exceed the rated voltage and shall not reverse voltage.</p> <p>Frequency Multipliers:</p> <table border="1" style="margin-left: auto; margin-right: auto;"> <tr> <td style="text-align: center;">Coefficient Freq. (Hz)</td> <td style="text-align: center;">120</td> <td style="text-align: center;">1k</td> <td style="text-align: center;">10k</td> <td style="text-align: center;">100k</td> </tr> <tr> <td style="text-align: center;">Cap. (μ F)</td> <td></td> <td></td> <td></td> <td></td> </tr> <tr> <td style="text-align: center;">6.8~180</td> <td style="text-align: center;">0.40</td> <td style="text-align: center;">0.75</td> <td style="text-align: center;">0.90</td> <td style="text-align: center;">1.00</td> </tr> </table> <p>Temperature Coefficient:</p> <table border="1" style="margin-left: auto; margin-right: auto;"> <tr> <td style="text-align: center;">Temperature ($^{\circ}$C)</td> <td style="text-align: center;">~55</td> <td style="text-align: center;">65</td> <td style="text-align: center;">75</td> <td style="text-align: center;">85</td> <td style="text-align: center;">105</td> </tr> <tr> <td style="text-align: center;">Factor</td> <td style="text-align: center;">1.73</td> <td style="text-align: center;">1.73</td> <td style="text-align: center;">1.73</td> <td style="text-align: center;">1.73</td> <td style="text-align: center;">1.00</td> </tr> </table>	Coefficient Freq. (Hz)	120	1k	10k	100k	Cap. (μ F)					6.8~180	0.40	0.75	0.90	1.00	Temperature ($^{\circ}$ C)	~55	65	75	85	105	Factor	1.73	1.73	1.73	1.73	1.00
Coefficient Freq. (Hz)	120	1k	10k	100k																									
Cap. (μ F)																													
6.8~180	0.40	0.75	0.90	1.00																									
Temperature ($^{\circ}$ C)	~55	65	75	85	105																								
Factor	1.73	1.73	1.73	1.73	1.00																								

5. Product Marking

Marking Details

Capacitor shall be marked the following items:

- 1) Nominal capacitance
Rated voltage
Series symbol (RT)
Tolerance: -20% ~ +20% (M)
- 2) Polarity: Cathode shall be marked with a black stripe and indicate "-" symbol on it.
- 3) Trademark (SAMXON)
- 4) Maximum operating temperature: 105°C
- 5) Date code numbering system

Table-A

Code	B	C	D	G
Year	2012	2013	2014	2017

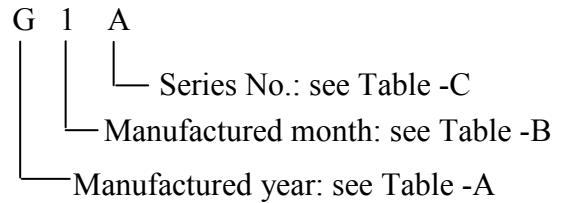

Table-B

Month	1	2	3	4	5	6	7	8	9	10	11	12
Code	1	2	3	4	5	6	7	8	9	O	N	D

Table-C

Series No.	1	2	3	4	5
Code	A	B	C	D	E

6) Marking Sample:

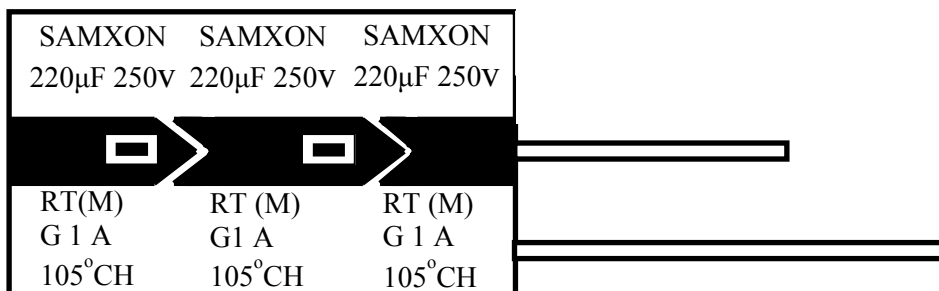

7) Sleeve color Black Ink Color White

6. Product Dimensions & Maximum Permissible Ripple Current

Unit: mm

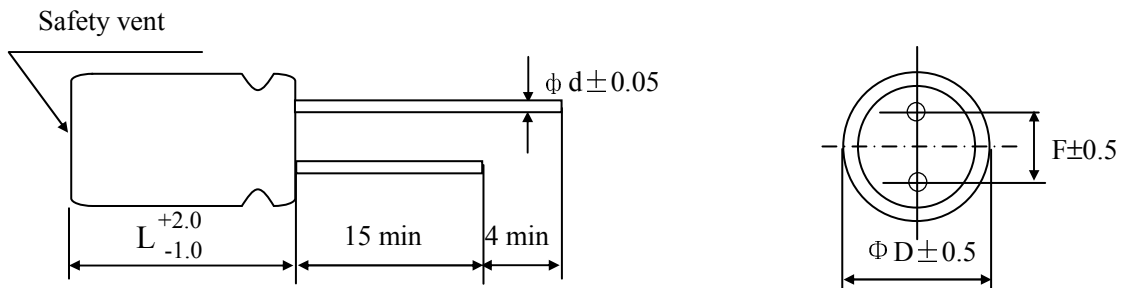

ϕD	18
L	35
F	7.5
ϕd	0.8

Table-3

Working Voltage (V)	Capacitance (μF)	Dimension (D \times L, mm)	Maximum Permissible Ripple Current at 105°C 120Hz (mA _{rms})
250	220	18x35	1110

7.It refers to the latest document of “Environment-related Substances standard”(WI-HSPM-QA-072).

Substances	
Heavy metals	Cadmium and cadmium compounds
	Lead and lead compounds
	Mercury and mercury compounds
	Hexavalent chromium compounds
Chloinated organic compounds	Polychlorinated biphenyls (PCB)
	Polychlorinated naphthalenes (PCN)
	Polychlorinated terphenyls (PCT)
	Short-chain chlorinated paraffins(SCCP)
	Other chlorinated organic compounds
Brominated organic compounds	Polybrominated biphenyls (PBB)
	Polybrominated diphenylethers(PBDE) (including decabromodiphenyl ether[DecaBDE])
	Other brominated organic compounds
Tributyltin compounds(TBT)	
Triphenyltin compounds(TPT)	
Asbestos	
Specific azo compounds	
Formaldehyde	
Beryllium oxide	
Beryllium copper	
Specific phthalates (DEHP,DBP,BBP,DINP,DIDP,DNOP,DNHP)	
Hydrofluorocarbon (HFC), Perfluorocarbon (PFC)	
Perfluorooctane sulfonates (PFOS)	
Specific Benzotriazole	

MAN YUE ELECTRONICS COMPANY LIMITED	ELECTROLYTIC CAPACITOR SPECIFICATION RT SERIES	SAMXON	

Attachment: Application Guidelines

1. Circuit Design

1.1 Operating Temperature and Frequency

Electrolytic capacitor electrical parameters are normally specified at 20°C temperature and 120Hz frequency. These parameters vary with changes in temperature and frequency. Circuit designers should take these changes into consideration.

- (1) Effects of operating temperature on electrical parameters
 - a) At higher temperatures, leakage current and capacitance increase while equivalent series resistance (ESR) decreases.
 - b) At lower temperatures, leakage current and capacitance decrease while equivalent series resistance (ESR) increases.
- (2) Effects of frequency on electrical parameters
 - a) At higher frequencies capacitance and impedance decrease while $\tan \delta$ increases.
 - b) At lower frequencies, ripple current generated heat will rise due to an increase in equivalent series resistance (ESR).

1.2 Operating Temperature and Life Expectancy

See the file: Life calculation of aluminum electrolytic capacitor

1.3 Common Application Conditions to Avoid

The following misapplication load conditions will cause rapid deterioration to capacitor electrical parameters. In addition, rapid heating and gas generation within the capacitor can occur causing the pressure relief vent to operate and resultant leakage of electrolyte. Under Leaking electrolyte is combustible and electrically conductive.

Issued-date: 2017-08-04	Name	Specification Sheet – RT		
Version	01		Page	18
STANDARD MANUAL				

MAN YUE ELECTRONICS COMPANY LIMITED	<i>ELECTROLYTIC CAPACITOR SPECIFICATION RT SERIES</i>	SAMXON	

- (1) Reverse Voltage
DC capacitors have polarity. Verify correct polarity before insertion. For circuits with changing or uncertain polarity, use DC bipolar capacitors. DC bipolar capacitors are not suitable for use in AC circuits.
- (2) Charge / Discharge Applications
Standard capacitors are not suitable for use in repeating charge / discharge applications. For charge / discharge applications consult us and advise actual conditions.
- (3) Over voltage
Do not apply voltages exceeding the maximum specified rated voltage. Voltages up to the surge voltage rating are acceptable for short periods of time. Ensure that the sum of the DC voltage and the superimposed AC ripple voltage does not exceed the rated voltage.
- (4) Ripple Current
Do not apply ripple currents exceeding the maximum specified value. For high ripple current applications, use a capacitor designed for high ripple currents or contact us with your requirements.
Ensure that allowable ripple currents superimposed on low DC bias voltages do not cause reverse voltage conditions.
- 1.4 Using Two or More Capacitors in Series or Parallel
- (1) Capacitors Connected in Parallel
The circuit resistance can closely approximate the series resistance of the capacitor causing an imbalance of ripple current loads within the capacitors. Careful design of wiring methods can minimize the possibility of excessive ripple currents applied to a capacitor.
- (2) Capacitors Connected in Series
Normal DC leakage current differences among capacitors can cause voltage imbalances. The use of voltage divider shunt resistors with consideration to leakage current can prevent capacitor voltage imbalances.
- 1.5 Capacitor Mounting Considerations
- (1) Double Sided Circuit Boards
Avoid wiring pattern runs, which pass between the mounted capacitor and the circuit board.
When dipping into a solder bath, excess solder may collect under the capacitor by capillary action and short circuit the anode and cathode terminals.
- (2) Circuit Board Hole Positioning
The vinyl sleeve of the capacitor can be damaged if solder passes through a lead hole for subsequently processed parts. Special care when locating hole positions in proximity to capacitors is recommended.
- (3) Circuit Board Hole Spacing
The circuit board holes spacing should match the capacitor lead wire spacing within the specified tolerances. Incorrect spacing can cause excessive lead wire stress during the insertion process. This may result in premature capacitor failure due to short or open circuit, increased leakage current, or electrolyte leakage.

Issued-date: 2017-08-04	Name	Specification Sheet – RT		
Version	01	Page	19	
STANDARD MANUAL				

MAN YUE ELECTRONICS COMPANY LIMITED	<i>ELECTROLYTIC CAPACITOR SPECIFICATION RT SERIES</i>	SAMXON	

- (4) Clearance for Case Mounted Pressure Relief vents
Capacitors with case mounted pressure relief vents require sufficient clearance to allow for proper vent operation. The minimum clearances are dependent on capacitor diameters as proper vent operation. The minimum clearances are dependent on capacitor diameters as follows.
φ 6.3~φ 16mm:2mm minimum, φ 18~φ 35mm:3mm minimum, φ 40mm or greater:5mm minimum.
- (5) Clearance for Seal Mounted Pressure Relief Vents
A hole in the circuit board directly under the seal vent location is required to allow proper release of pressure.
- (6) Wiring Near the Pressure Relief Vent
Avoid locating high voltage or high current wiring or circuit board paths above the pressure relief vent. Flammable, high temperature gas exceeding 100°C may be released which could dissolve the wire insulation and ignite.
- (7) Circuit Board patterns Under the Capacitor
Avoid circuit board runs under the capacitor as electrolyte leakage could cause an electrical short.
- (8) Screw Terminal Capacitor Mounting
Do not orient the capacitor with the screw terminal side of the capacitor facing downwards.
Tighten the terminal and mounting bracket screws within the torque range specified in the specification.
- 1.6 Electrical Isolation of the Capacitor
Completely isolate the capacitor as follows.
- (1) Between the cathode and the case (except for axially leaded B types) and between the anode terminal and other circuit paths
- (3) Between the extra mounting terminals (on T types) and the anode terminal, cathode terminal, and other circuit paths.
- 1.7 The Product characteristic should take the sample as the standard.
- 1.8 If conduct the load or shelf life test, must be collect date code within 6 months products of sampling.
- 1.9 Capacitor Sleeve
The vinyl sleeve or laminate coating is intended for marking and identification purposes and is not meant to electrically insulate the capacitor.
The sleeve may split or crack if immersed into solvents such as toluene or xylene, and then exposed to high temperatures.

CAUTION!

Always consider safety when designing equipment and circuits. Plan for worst case failure modes such as short circuits and open circuits which could occur during use.

- (1) Provide protection circuits and protection devices to allow safe failure modes.
(2) Design redundant or secondary circuits where possible to assure continued operation in case of main circuit failure.

Issued-date: 2017-08-04	Name	Specification Sheet – RT		
Version	01		Page	20
STANDARD MANUAL				

MAN YUE ELECTRONICS COMPANY LIMITED	ELECTROLYTIC CAPACITOR SPECIFICATION RT SERIES	SAMXON	

2. Capacitor Handling Techniques

2.1 Considerations Before Using

- (1) Capacitors have a finite life. Do not reuse or recycle capacitors from used equipment.
- (2) Transient recovery voltage may be generated in the capacitor due to dielectric absorption. If required, this voltage can be discharged with a resistor with a value of about $1k\ \Omega$.
- (3) Capacitors stored for long periods of time may exhibit an increase in leakage current. This can be corrected by gradually applying rated voltage in series with a resistor of approximately $1k\ \Omega$.
- (4) If capacitors are dropped, they can be damaged mechanically or electrically. Avoid using dropped capacitors.
- (5) Dented or crushed capacitors should not be used. The seal integrity can be compromised and loss of electrolyte / shortened life can result.

2.2 Capacitor Insertion

- * (1) Verify the correct capacitance and rated voltage of the capacitor.
- * (2) Verify the correct polarity of the capacitor before inserting.
- * (3) Verify the correct hole spacing before insertion (land pattern size on chip type) to avoid stress on the terminals.
- (4) Ensure that the auto insertion equipment lead clinching operation does not stress the capacitor leads where they enter the seal of the capacitor.

For chip type capacitors, excessive mounting pressure can cause high leakage current, short circuit, or disconnection.

2.3 Manual Soldering

- (1) Observe temperature and time soldering specifications or do not exceed temperatures of $400\ ^\circ\text{C}$ for 3 seconds or less.
- (2) If lead wires must be formed to meet terminal board hole spacing, avoid stress on the lead wire where it enters the capacitor seal.
- (3) If a soldered capacitor must be removed and reinserted, avoid excessive stress to the capacitor leads.
- (4) Avoid touching the tip of the soldering iron to the capacitor, to prevent melting of the vinyl sleeve.

2.4 Flow Soldering

- (1) Do not immerse the capacitor body into the solder bath as excessive internal pressure could result.
- (2) Observe proper soldering conditions (temperature, time, etc.) Do not exceed the specified limits.
- (3) Do not allow other parts or components to touch the capacitor during soldering.

2.5 Other Soldering Considerations

Rapid temperature rises during the preheat operation and resin bonding operation can cause cracking of the capacitor vinyl sleeve.

For heat curing, do not exceed 150°C for a maximum time of 2 minutes.

Issued-date: 2017-08-04	Name	Specification Sheet – RT		
Version	01		Page	21
STANDARD MANUAL				

MAN YUE ELECTRONICS COMPANY LIMITED	<i>ELECTROLYTIC CAPACITOR SPECIFICATION RT SERIES</i>	SAMXON	

2.6 Capacitor Handling after Solder

- (1). Avoid movement of the capacitor after soldering to prevent excessive stress on the lead wires where they enter the seal.
- (2). Do not use capacitor as a handle when moving the circuit board assembly.
- (3). Avoid striking the capacitor after assembly to prevent failure due to excessive shock.

2.7 Circuit Board Cleaning

- * (1) Circuit boards can be immersed or ultrasonically cleaned using suitable cleaning solvents for up to 5 minutes and up to 60°C maximum temperatures. The boards should be thoroughly rinsed and dried.
The use of ozone depleting cleaning agents is not recommended in the interest of protecting the environment.
- * (2) Avoid using the following solvent groups unless specifically allowed for in the specification;
 - Halogenated cleaning solvents: except for solvent resistant capacitor types, halogenated solvents can permeate the seal and cause internal capacitor corrosion and failure. For solvent resistant capacitors, carefully follow the temperature and time requirements of the specification. 1-1-1 trichloroethane should never be used on any aluminum electrolytic capacitor.
 - Alkali solvents : could attack and dissolve the aluminum case.
 - Petroleum based solvents: deterioration of the rubber seal could result.
 - Xylene : deterioration of the rubber seal could result.
 - Acetone : removal of the ink markings on the vinyl sleeve could result.
- * (3) A thorough drying after cleaning is required to remove residual cleaning solvents which may be trapped between the capacitor and the circuit board. Avoid drying temperatures, which exceed the maximum rated temperature of the capacitor.
- * (4) Monitor the contamination levels of the cleaning solvents during use by electrical conductivity, pH, specific gravity, or water content. Chlorine levels can rise with contamination and adversely affect the performance of the capacitor.
Please consult us for additional information about acceptable cleaning solvents or cleaning methods.

2.8 Mounting Adhesives and Coating Agents

When using mounting adhesives or coating agents to control humidity, avoid using materials containing halogenated solvents. Also, avoid the use of chloroprene based polymers.

After applying adhesives or coatings, dry thoroughly to prevent residual solvents from being trapped between the capacitor and the circuit board.

3. Precautions for using capacitors

3.1 Environmental Conditions

Capacitors should not be stored or used in the following environments.

- * (1) Temperature exposure above the maximum rated or below the minimum rated temperature of the capacitor.
- * (2) Direct contact with water, salt water, or oil.
- * (3) High humidity conditions where water could condense on the capacitor.

Issued-date: 2017-08-04	Name	Specification Sheet – RT		
Version	01		Page	22
STANDARD MANUAL				

MAN YUE ELECTRONICS COMPANY LIMITED	ELECTROLYTIC CAPACITOR SPECIFICATION RT SERIES	SAMXON	

- * (4) Exposure to toxic gases such as hydrogen sulfide, sulfuric acid, nitric acid chlorine, or ammonia.
- * (5) Exposure to ozone, radiation, or ultraviolet rays.
- * (6) Vibration and shock conditions exceeding specified requirements.

3.2 Electrical Precautions

- (1) Avoid touching the terminals of the capacitor as possible electric shock could result. The exposed aluminum case is not insulated and could also cause electric shock if touched.
- (2) Avoid short circuit the area between the capacitor terminals with conductive materials including liquids such as acids or alkaline solutions.

4. Emergency Procedures

- (1) If the pressure relief vent of the capacitor operates, immediately turn off the equipment and disconnect from the power source. This will minimize additional damage caused by the vaporizing electrolyte.
- (2) Avoid contact with the escaping electrolyte gas which can exceed 100°C temperatures.
 - If electrolyte or gas enters the eye, immediately flush the eyes with large amounts of water.
 - If electrolyte or gas is ingested by mouth, gargle with water.
 - If electrolyte contacts the skin, wash with soap and water.

5. Long Term Storage

Leakage current of a capacitor increases with long storage times. The aluminum oxide film deteriorates as a function of temperature and time. If used without reconditioning, an abnormally high current will be required to restore the oxide film. This current surge could cause the circuit or the capacitor to fail.

After one year, a capacitor should be reconditioned by applying rated voltage in series with a 1000 Ω ,current limiting resistor for a time period of 30 minutes .

If the expired date of products date code is over eighteen months, the products should be return to confirmation.

5.1 Environmental Conditions

The capacitor shall be not use in the following condition:

- (1) Temperature exposure above the maximum rated or below the minimum rated temperature of the capacitor.
- (2) Direct contact with water, salt water, or oil.
- (3) High humidity conditions where water could condense on the capacitor.
- (4) Exposure to toxic gases such as hydrogen sulfide, sulfuric acid, nitric acid, chlorine, or ammonia.
- (5) Exposure to ozone, radiation, or ultraviolet rays.
- (6) Vibration and shock conditions exceeding specified requirements.

6. Capacitor Disposal

When disposing of capacitors, use one of the following methods.

- * Incinerate after crushing the capacitor or puncturing the can wall (to prevent explosion due to internal pressure rise). Capacitors should be incinerated at high temperatures to prevent the release of toxic gases such as chlorine from the polyvinyl chloride sleeve, etc.
- * Dispose of as solid waste.

NOTE: Local laws may have specific disposal requirements, which must be followed.

Issued-date: 2017-08-04	Name	Specification Sheet – RT		
Version	01		Page	23
STANDARD MANUAL				